



**Generating Set
Base Frame - diesel**

GE.BD.385/350.BF+011

1500 rpm - Threephase - 50Hz - 400V
Automatic Panel with AMF without ATS



Image for demonstration purposes

Standard equipment

⚙️ Exhaust

Exhaust manifold protection
Silenced muffler -15dB(A)

⚙️ Fuel Supply

Single wall daily tank with bunded base
Automatic shutdown system for low fuel level
Fuel gauge

⚙️ Handling

N.4 lifting hooks integrated into the bearing structure

⚙️ Base Frame

Bunded base at 110% of fuel tank capacity
Anti-vibrating mounting pads

⚙️ Engine

High coolant temperature and low oil pressure shutdown system
Oil pressure and coolant temperature gauge (only with qpe or +14 variant)
External oil drain points
Engine liquids (oil and antifreeze)
Tropicalized radiator
Rotating parts protection
Electronic speed governor

⚙️ Alternator

Avr automatic voltage regulator
Avr pre-arranged for parallel
Impregnation for marine environment
Ip23

⚙️ Panel & connection

Emergency stop button
Magnetothermal circuit breaker on alternator board
Cable output from side
Ip44 wiring
Start-up battery (pre-charged)
Grounding point

⚙️ Documentation

Ce conformity declaration
User and maintenance manual
Wirings diagrams

⚙️ Normatives

All generating sets are compliant to CE marking
2014/30/UE electromagnetic compatibility
2000/14/CE noise emission for outdoor use
Factory-designed systems built according to ISO 9001:2015
CEI EN 60204-1:2018 - Electrical equipment of machines

Primary data

General Information

Speed	RPM	1500
Frequency	Hz	50
PRP	KVA	350
Prp - prime power	KW	280,0
Ltp - standby power	KVA	385
Ltp - standby power	KW	308,0
Standard voltage	V	400/230
Current	A	505,8
Cosfi	0,8	0,8

General electrical protection

Circuit-breaker rated current	A	630
Type		Magnetothermal switch on the alternator board
Circuit-breaker poles	N	4P

Fuel Consumption

Type		diesel
Standard fuel tank capacity	lt	400
Autonomy @ 75% load	h	7
Fuel consumption at 100% load	lt/h	82,1
Fuel consumption at 75% load	lt/h	60,6
Fuel consumption at 50% load	lt/h	40,9

General data

Rated capacity	Ah	2x120
Auxiliary voltage	V	24
Exhaust gas temperature	°C	580

Weight and Dimensions

Dimensions (l x w x h)	cm	300x135x188
Weight with liquids (excluding optionals and fuel)	Kg (+/-3%)	2911

Engine

Factory		Baudouin
Model		6M21G385/5
Emissions stage		Stage 0
Speed governor		Electronic
Radiator	°C	50
Cooling	Tipo	liquid (water + 50% Paraflu11)
Active net power	Kwm	327
Nominal net power	CV	444,3
Cycle	Tipo	4 strokes
Aspiration	Tipo	Turbo
Numbers of cylinders	N	6
Cylinders arrangement		L
Bore	mm	127
Stroke	mm	165
Total displacement	lt	12,535
Engine oil features		15W40-API CI-4/CH-4 ACEA E5-E7
Total oil capacity	lt	32
Total coolant capacity	lt	55
Iso 8528-5 class		G2

Alternator

*** May vary based on stock availability. However, a primary brand will be used.**

Factory		Stamford
Model		S4L1D-E
Prime power prp 3ph+n	KVA	360
Voltage regulator (voltage accuracy)	+/- %	1
Poles	N°	4
Phases	N°	3+N
Standard windings connection		Star Series
Stator/rotor impregnation		H (Outdoor Temp 40°C)
Efficiency	%	93,3
Engine coupling		Elastic disk
Short circuit current		>= 300% (3In)
Protection degree	IP	23
Cooling system		Self ventilating
Maxium overspeed	rpm	2250
Waveform distortion	%	<5
Exciter		Diode bridge

Standard operating environmental conditions

Ambient temperature	°C	25
Relative humidity	%	30
Max altitude	mt	1000

Control Systems on board QPE-C-VSC-BF

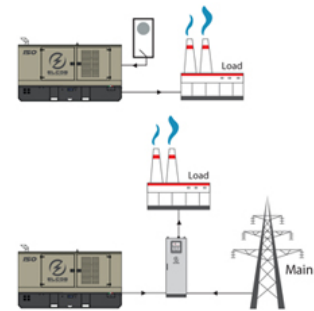

operating scheme - schema di funzionamento

QPE Automatic panel without switching on board

The QPE-C control panel represents the evolution of the panel for the control and management of the gen set. With its microprocessor logic it is able to meet any user requested features. The dual operation mode manual and automatic guarantees to every type of functionality protection, analysis and control of the generating set in order to make the management easy and efficient. Variant without transfer switch on board. ATS panel type QC as optional. The panel manages the QC panels directly or any other ATS panel.

Mechanical features

Protection degree	IP	55
-------------------	----	----

Battery charger

Model		ELCOS - CB1
Maximum output current	A	2,5
Output dc voltage (selectable)	Vdc	12-24
Input ac voltage (selectable)	Vac	220-260
Frequency	Hz	50-60

Data Communication

Data connection port		RS-485
Communication protocol		Mod-bus RTU-8N1

Remotable functions in terminal box

Gs start	Gs lock
Genset contactor close/open command	Mains contactor close/open command
Common alarm - dc output	Gs test without load
Gs start with key in off position (only in mrs mode)	Programmable output - volt free output
Management of the automatic fuel refilling system	

Control Module



Brand	ELCOS
Model	MC4
Operating mode	AMF - MRS

Specifics

Applications

Emergency to the mains
Stand-alone
Construction site/rental
Self-production

ENGINE MEASURES

Fuel tank level %
Engine oil pressure bar (1)
Engine coolant temperature °c (1)
Total run time
Partial run time
Hours to maintenance
Battery voltage
Battery charging voltage
Start-ups counter
Engine speed (2)
Engine oil temperature (2)
Cooler temperature (2)
Engine oil level (2)
Engine coolant level (2)
Engine coolant pressure (2)
Turbo pressure (2)
Fuel consumption (2)
Tank autonomy - hrs (5)
Fuel remaining quantity (5)
Fuel used quantity (5)

ALTERNATOR MEASURES

Generator voltage I1, I2, I3
Generator voltage I1-n, I2-n, I3-n
Generator frequency
Generator current I1, I2, I3
Generator apparent power kva
Generator active power kw
Generator reactive power kvar
Generator accumulated power kwh
Power factor cosfi

MAINS MEASURES

Mains voltage I1, I2, I3
Mains voltage I1-n, I2-n, I3-n
Mains frequency

COMMUNICATION PORTS

Can-bus port
Rs485 port with mod-bus rtu communication
Rs232 port for display connection
Usb port for parameters saving and firmware update

EQUIPMENT

Microprocessor logic
Back-lit display
Programmable from display
16 event log
Multiple display languages
Stop button
Start button
Test button
Reset alarm button
Alarm mute button
Fuel transfer pump activation button
Glow-plug activation button

PRE-ALARMS/ ALARMS

Common alarm
Fuel reserve (pre-alarm)
Low fuel level (alarm)
Tank overflow
Charge alternator failed (dinamo)
Low oil pressure (pre-alarm) (1)
Low oil pressure (alarm)
Oil sensor failed (alarm)
High coolant temperature (pre-alarm) (1)
High coolant temperature (alarm)
Low coolant temperature (pre-alarm)
Low water level (1)
Water in fuel (1)
Battery undervoltage
Battery overvoltage
Gs failure to start
Gs failure to stop
Can-bus failure
No can-bus communication
Genset overload I1, I2, I3 phases
Genset short circuit
Genset overvoltage
Genset undervoltage
Genset high frequency
Genset low frequency
Overspeed
Reverse power
Earth fault (pre-alarm)
Earth fault (alarm)
Block from password
Can communication failed
Maintenance request
Emergency button pressed
Remote emergency active
Forced stop
External battery failed
Fuel theft
Genset negative phase sequence
Mains negative phase sequence
Fuel theft protection

VISUALIZATIONS ON CONTROL MODULE/DISPLAY

Pre-alarms
Alarms
Engine measures
Alternator measures
Mains measures
Date and time
Operating mode
Genset status
Mains status
Mains contactor status
Genset contactor status
Digital input and output status
Grounding current ma (3)
Grounding current threshold ma (3)
Delay time of differential protection (3)
Glow plugs status

CONTROL MODULE FUNCTIONS

Automatic start and stop when the mains fails (7)
Remote start and stop
Remote start and stop with key in off position
Manual start and stop
Emergency stop button on panel board
Remote emergency stop
Remote lock
Remote test without load
Remote test on load
Scheduled start-ups
Modbus commands (start, stop, reset, test)

CONTROL MODULE SPECIAL FUNCTIONS (on demand)

Automatic charging of an external battery
Dummy load (4)
Load shedding (4)
Redundant starter motor management
Fuel monitoring
Gs battery load test
Idle mode
Service phone number indication
Variable speed generator
Master / slave mode

OPTIONAL

Canopy Soundproofing

Air inlet/outlet sound attenuator for room
Soundproof container of various sizes

Exhaust

Exhaust flexible expansion joint
External residential muffler
Exhaust flexible pipe
(fap) anti-particulate filter
Exhaust catalyst (cat)

Fuel Supply

Bulk tank connections with 3 way valve
Bulk tank connections
Automatic fuel refilling system on board

Engine

Engine pre-heater 230vsuper hot
Oil change pump
Engine liquids + 50°C, - 40°C (oil and antifreeze)
Battery disconnecter
Automatic refilling oil system
1000 working hours spare parts kit
Cyclone air filter
Redundant start-up battery kit

Alternator

Stator windings thermistors - pt100 - in the alternator box (not managed)
Bearing thermistor - pt100 - in the alternator box (not managed)
Anti-condensation heater
Double bearing
Three-phase sensing avr
Bi-phase sensing avr

Panel & connection

Rcd with adjustable current and excludible
Automatic transfer switch (qc)
Utf energy meter with arcudi terminal
Tamperproof panel ip55

MC4 optional

Telemonitoring with software
Remote panel
Rs485/usb converter
Rs485/lan converter
16 relais card (volt free output)
Gms modem - sms remote management
Radiocontrol
Gsm remote control system with web application without sim card
Gps tracking system

PRP

Engines of this rating provide unlimited hours of usage in a variable load application. The average load factor should not exceed 70% of the engine's prime power rating with a maximum number of 500 operational hours at 100% prime power rating. An overload capability of 10% is available, however, is limited to a period of 1 in every 12 hours

LTP

Limited-time running power is defined as the maximum power available, under the agreed operating conditions, for which the generating set is capable of delivering for up to 500h of operation per year with the maintenance intervals. The overload is not allowed.

Sheet: B3000	OPEN FRAME	Exhaust side:	Type: STANDARD	Rev: 00	Last Update: Mar 20, 2019	Page 1/2
--------------	------------	---------------	----------------	---------	---------------------------	----------

OVERALL DIMENSIONS [mm]

REAR VIEW

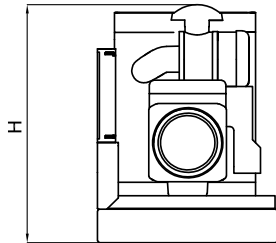

LEFT SIDE VIEW

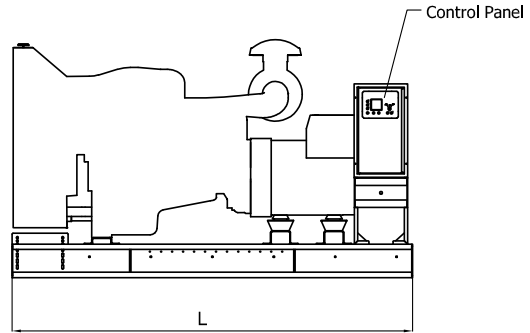

FRONT VIEW

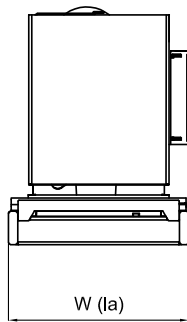

RIGHT SIDE VIEW

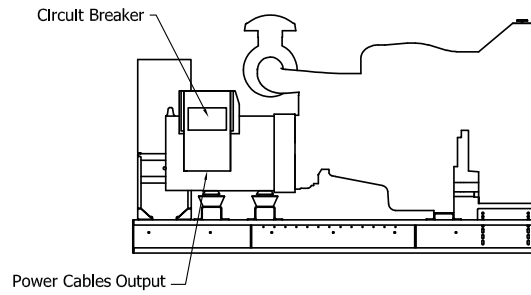

TOP VIEW

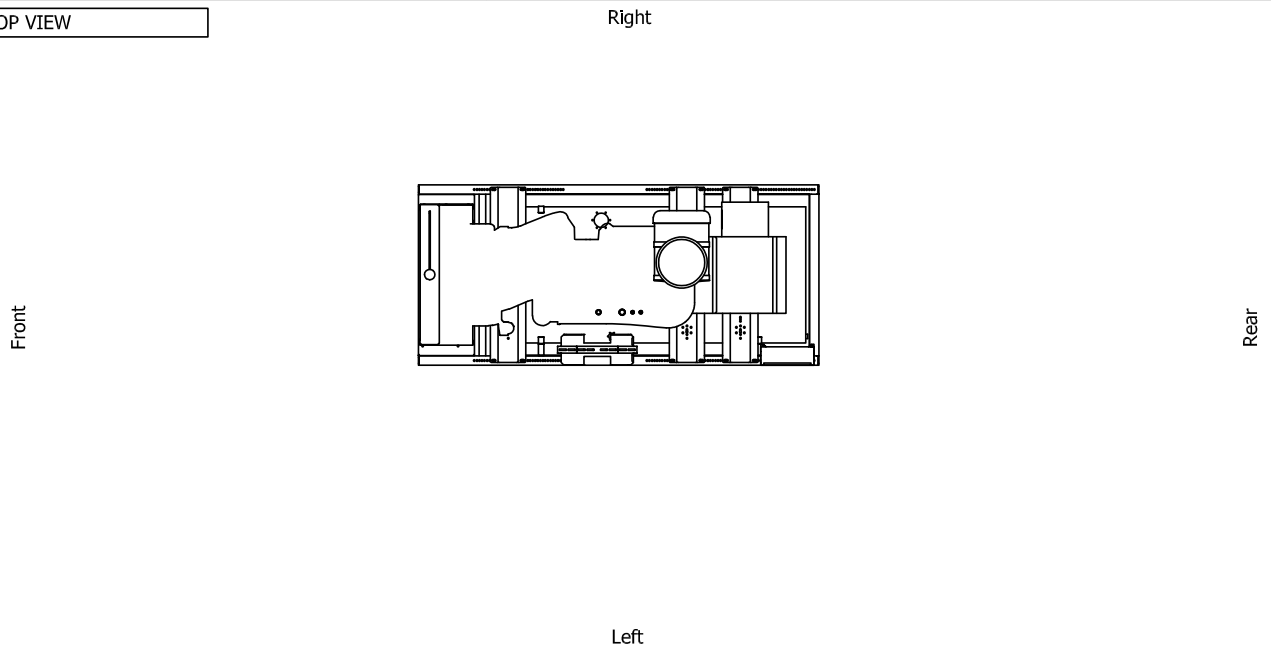

IMPORTANT:

- 1) Form and dimension refer to the generating set on catalogue
- 2) Form and dimension are subject to change in order to update or improve the products
- 3) This document can not be copied or trasmitted without ELCOS S.r.l. approval

Sheet:	B3000	OPEN FRAME	Exhaust side:	Type:	STANDARD	Rev:	00	Last Update:	Mar 20, 2019	Page 2/2
--------	-------	------------	---------------	-------	----------	------	----	--------------	--------------	----------

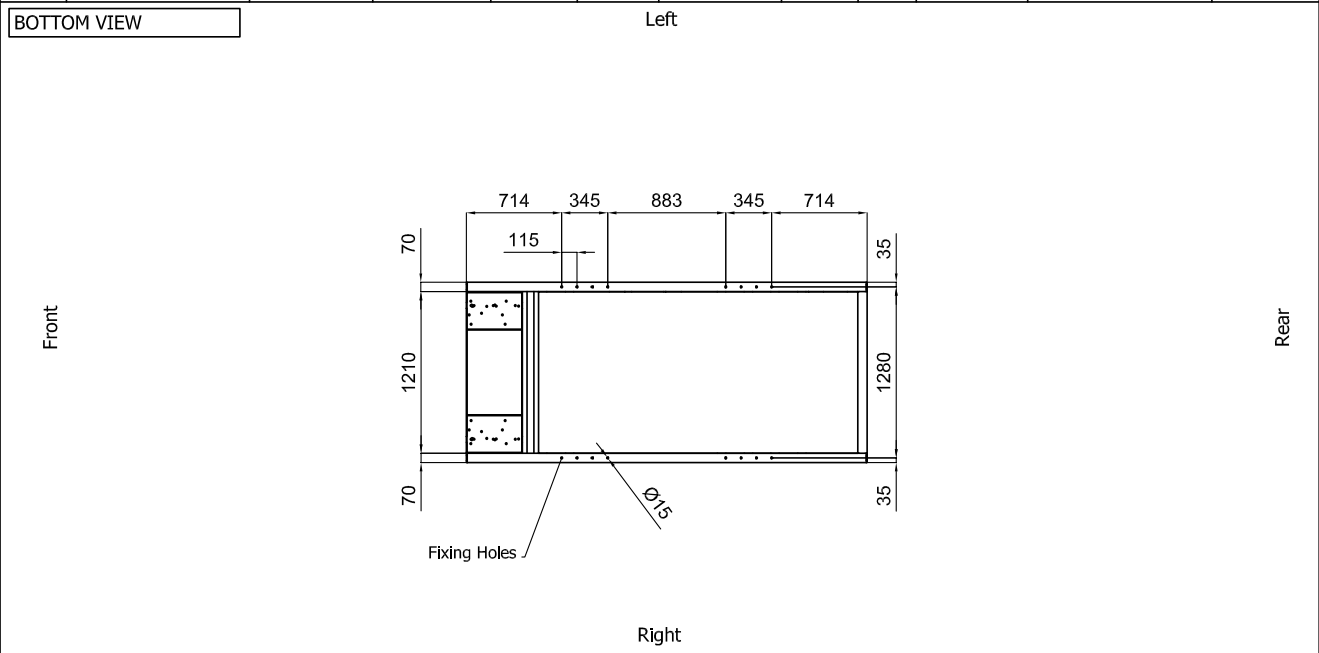

DIMENSIONS WITH OPEN DOORS [mm]

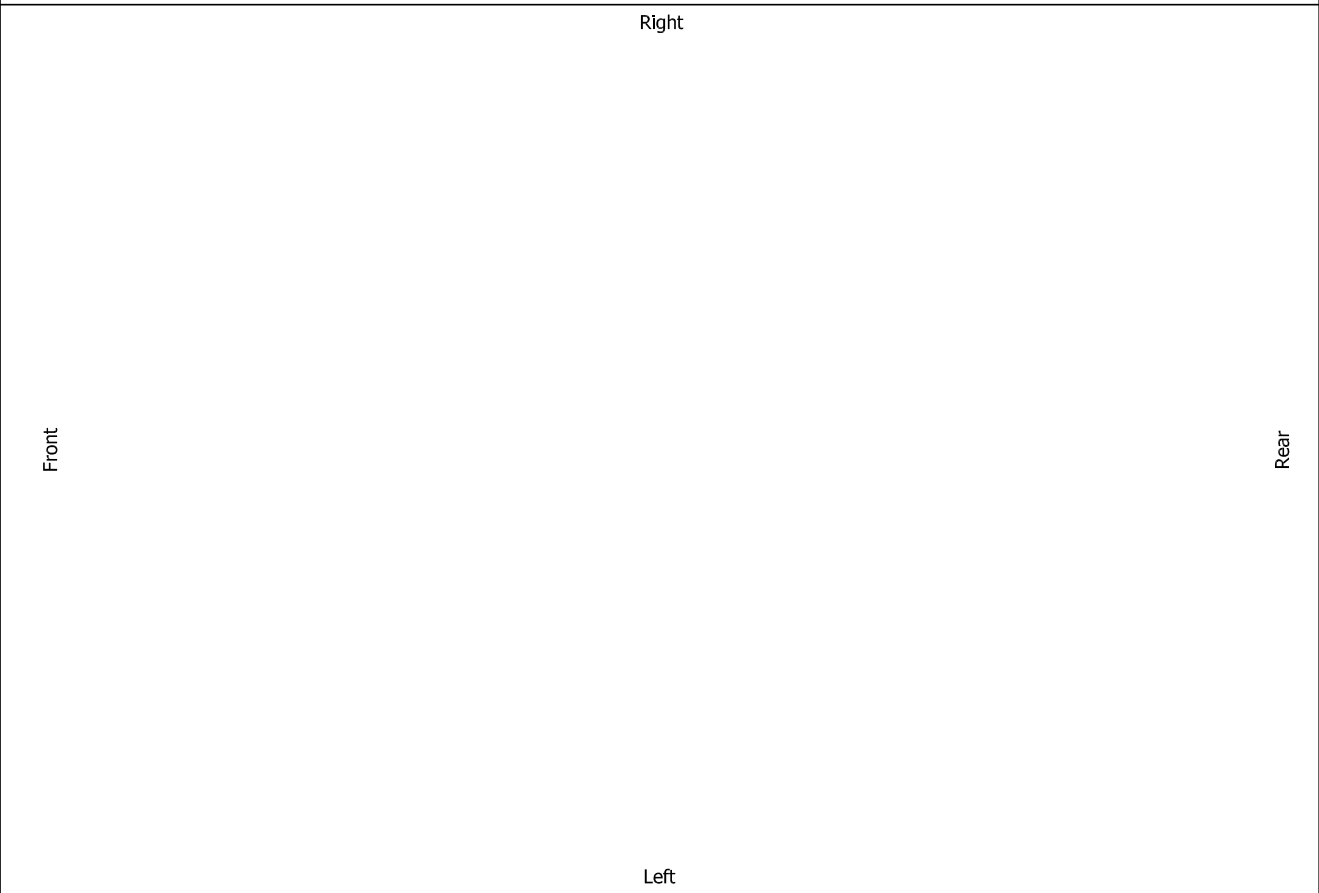

VENTILATION OF THE ROOM

The windows area in the generating set room needs to be (recommended):
 Aspiration: on request
 Expulsion: on request
ATTENTION: for a correct ventilation the expulsion air and the exhaust gas needs to be conveyed in the open-air

- IMPORTANT:**
- 1) Form and dimension refer to the generating set on catalogue
 - 2) Form and dimension are subject to change in order to update or improve the products
 - 3) This document can not be copied or transmitted without ELCOS S.r.l. approval